

vertex

Drawer Cassetto Cajón
Tiroir Gaveta Szufłada

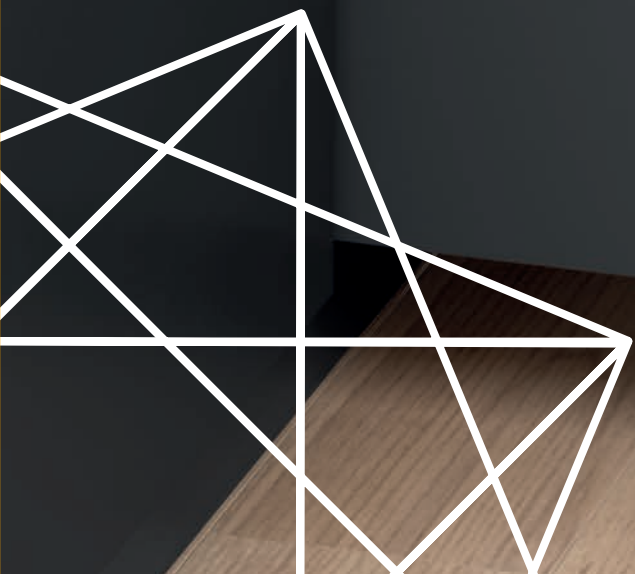

furniture fittings solutions

Index

- 04 Vertex drawer
- 06 Characteristics
- 08 Drawer kit
- 10 Exterior drawer
- 16 Railing
- 18 Inner drawer
- 22 Accessories
- 24 Under-sink insert
- 26 Assembly



vertex



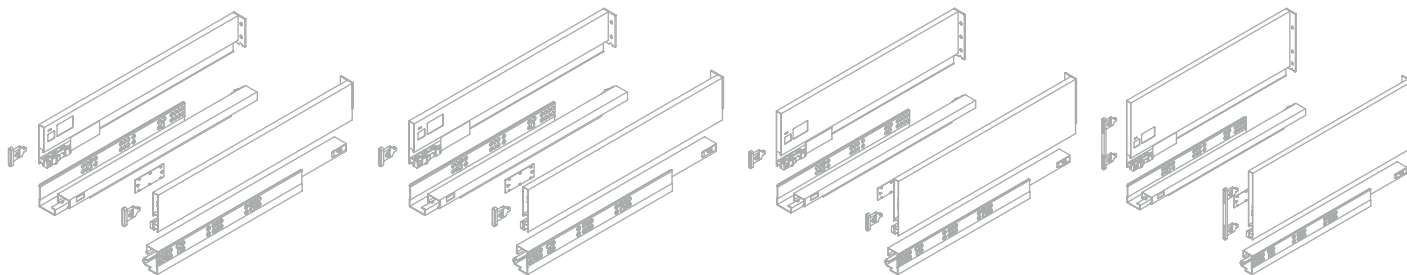

Discover the new Vertex drawer, with an elegant extra fine design and straight lines, perfect to equip your furniture following the latest trends in design and functionality.

Scopri il nuovo cassetto Vertex con un elegante design super fine e linee rette, perfetto per arredare i tuoi mobili con l'ultima tendenza in termini di design e funzionalità.

Descubre el nuevo cajón Vertex con un elegante diseño extrafino de líneas rectas, perfecto para equipar tus muebles con la última tendencia en diseño y funcionalidad.

Découvrez le nouveau tiroir Vertex avec sa conception élégante et son design aux lignes droites, parfait pour équiper vos meubles aux dernières tendances en matière de design et de fonctionnalité.

Descubra a nova gaveta Vertex com um elegante desenho extrafino de linhas direitas, perfeita para equipar os seus móveis de acordo com as últimas tendências tanto em desenho como em funcionalidade.

Przedstawiamy nową szufladę Vertex odznaczającą się wyrafinowanym, eleganckim designem, dzięki której Twoje meble będą prezentować najnowsze trendy zarówno we wzornictwie, jak i funkcjonalności.



Characteristics

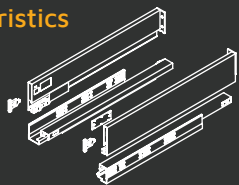



It stands out for its three telescopic runner slides, of reduced height, offering great stability and soft sliding of the drawer. It can support 40 kg and with push to open or soft close and a cushioned pull-out stopper.

Si distingue per le sue guide telescopiche a tre corpi, di altezza ridotta, che offrono una grande stabilità e uno scivolamento morbido del cassetto. Dispongono di una capacità di carico fino a 40 kg, con push o chiusura soft del cassetto e arresto di estrazione ammortizzato.

Destaca por sus guías de tres cuerpos telescópicas, de altura reducida, que ofrecen una gran estabilidad y deslizamiento suave del cajón. Disponen de una capacidad de carga de 40 kg, con push o cierre suave del cajón y tope de extracción amortiguado.

Il se distingue par ses coulisses en 3 parties télescopiques, de hauteur réduite, qui offrent une grande stabilité et un glissement en douceur du tiroir. Il dispose d'une capacité de charge de 40 kg, avec push ou une fermeture douce et un amortisseur en extraction.

Destaca pelas suas corredeiras de três corpos telescópicas, de altura reduzida, que oferecem uma grande estabilidade e um deslizamento muito suave à gaveta. A sua capacidade de carga é de 40 kg, com com tic tac ou fecho suave soft e batente de extração amortecido.

Szufłada ma trzyczęściowe prowadnice teleskopowe o zmniejszonej wysokości, które zapewnią dużą stabilność i płynne przesuwanie. Vertex ma udźwig 40 kg, cichy push to open czy domyk i amortyzowany ogranicznik wyciągania.

The drawer's ribs are available in a white satin finish (RAL9003) or anthracite grey (RAL7043) in four different heights (83, 93, 131 and 178 mm) and different depths.

I fianchi del cassetto sono disponibili in finitura bianco satinato (RAL9003) o grigio antracite (RAL7043), con quattro altezze differenti 83, 93, 131 e 178 mm e diverse profondità del cassetto.

Las costillas del cajón están disponibles en acabado blanco satinado (RAL9003) o gris antracita (RAL7043), con cuatro alturas diferentes 83, 93, 131 y 178 mm y distintas profundidades de cajón.

Les parois du tiroir sont disponibles en finition blanc satiné (RAL9003) ou gris anthracite (RAL7043), avec quatre hauteurs différentes 83, 93, 131 et 178 mm et différentes profondeurs de tiroir.

As ilhargas de gaveta estão para já disponíveis em acabamento branco satinado (RAL9003) e cinzento antracite (RAL7043), com três alturas diferentes 93, 131 e 178 mm e diferentes profundidades de gaveta.

Boki szufłady są dostępne w kolorze białym satynowym (RAL9003) lub szarym antracytowym (RAL7043), oferujemy te szufłady w czterech różnych wysokościach 83, 93, 131 i 178 mm i różnych głębokościach.

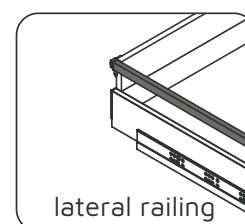
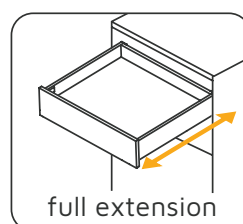
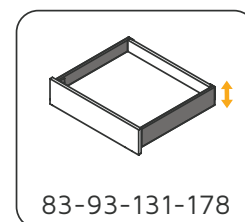
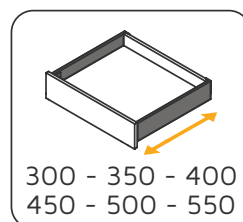
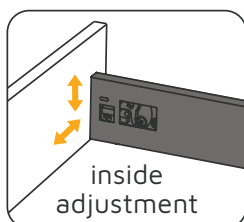
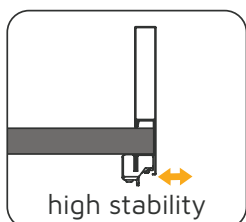
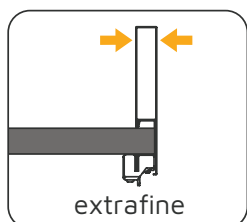

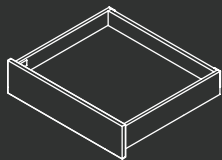

Drawer
kit

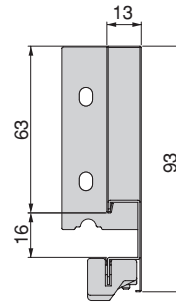

Exterior drawer kit / Kit cassetto esterno / Kit cajón exterior / Kit tiroir extérieur / Kit gaveta exterior / Zestaw szuflady zewnętrznej





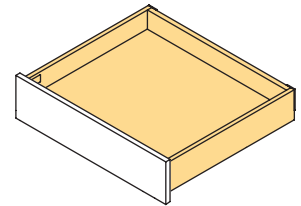

Prof. Depth	Cod.		
450	31730	35	1
600	31731	35	1
900	31732	35	1

Steel

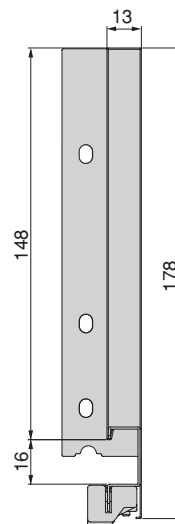

Exterior drawer kit / Kit cassetto esterno / Kit cajón exterior / Kit tiroir extérieur / Kit gaveta exterior / Zestaw szuflady zewnętrznej

Prof. Depth	Cod.		
450	31733	35	1
600	31734	35	1
900	31735	35	1

Steel

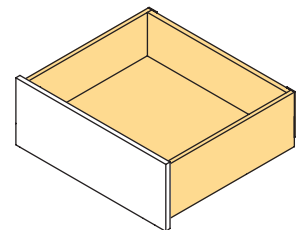

- Includes slides, metal sides, kit of front clip for external drawer, back and bottom.
- Include guide, fianco, coppia di agganci frontali per cassetto esterno, la schiena ed il fondo.
- Incluye guías, costillas, juego de enganches frontales para cajón exterior, trasera y fondo.
- Le kit inclu coulisses, côtés métalliques, jeu d'attaches arrières, jeu d'attaches façade pour tiroir extérieur, l'arrière et le fond de tiroir.
- Inlucui corrediças, laterais, jogo de engates frontais para gaveta, traseira e fundo.
- Zawiera prowadnice, metalowe boki, zestaw zacisków frontowych do szuflady zewnętrznej, tyłu i dna.



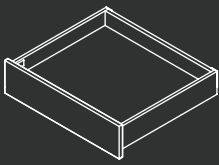

Exterior drawer / Cassetto esterno / Cajón exterior / Tiroir extérieur / Gaveta exterior / Szuflada zewnętrzna

Prof. Depth	Cod.			
450	31699	12	35	1
500	31700	12	35	1

Steel

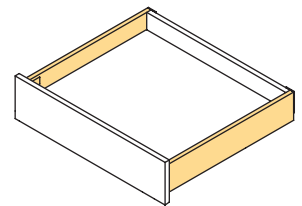
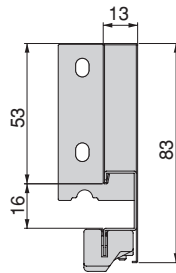

Exterior drawer / Cassetto esterno / Cajón exterior / Tiroir extérieur / Gaveta exterior / Szuflada zewnętrzna

Prof. Depth	Cod.			
300	31702	12	35	1
350	31703	12	35	1
400	31704	12	35	1
450	31705	12	35	1
500	31706	12	35	1
550	31707	12	35	1

Steel

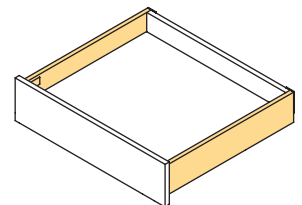
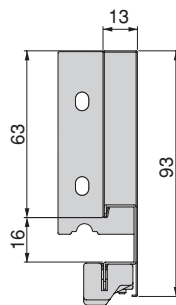

- The code includes all the elements for the assembly of an exterior drawer except the front, back and bottom.
- Includes slides, metal sides and kit of front clip for external drawer.
- Il codice include tutti gli elementi per il montaggio di un cassetto esterno ad eccezione del frontale, la schiena ed il fondo.
- Include guide, fianco e coppia di agganci frontali per cassetto esterno.
- El código incluye todos los elementos para el montaje de un cajón exterior a excepción de la frontera, trasera y fondo.
- Incluye guías, costillas y juego de enganches frontales para cajón exterior.

Exterior drawer / Cassetto esterno / Cajón exterior / Tiroir extérieur / Gaveta exterior / Szuflada zewnętrzna

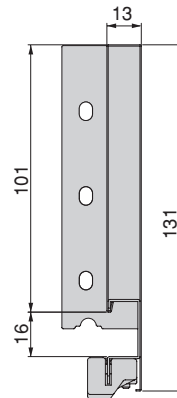

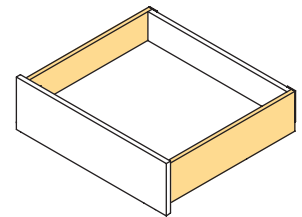

Prof. Depth	Cod.			
300	31709	12	35	1
350	31710	12	35	1
400	31711	12	35	1
450	31712	12	35	1
500	31713	12	35	1

Steel

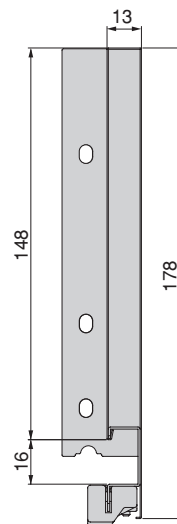

Exterior drawer / Cassetto esterno / Cajón exterior / Tiroir extérieur / Gaveta exterior / Szuflada zewnętrzna



Prof. Depth	Cod.			
350	31716	12	35	1
400	31717	12	35	1
450	31718	12	35	1
500	31719	12	35	1

Steel

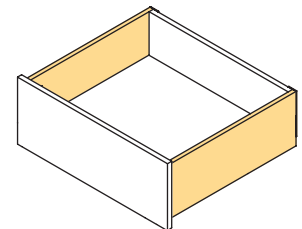

- Chaque kit inclu tous les éléments pour monter un tiroir sauf la façade avant, l'arrière et le fond de tiroir.
- Le kit inclu coulisses, côtés métalliques et jeu d'attaches façade pour tiroir extérieur.
- O código inclui todos os elementos para a montagem de uma gaveta exterior à exceção da frente, traseira e fundo.
- Includi corrediças, laterais e jogo de engates frontais para gaveta.
- Kod zawiera wszystkie elementy do montażu szuflady zewnętrznej z wyjątkiem frontu, tyłu i dna.
- Zawiera prowadnice, metalowe boki, zestaw zacisków frontowych do szuflady zewnętrznej.



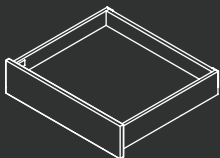

Exterior drawer / Cassetto esterno / Cajón exterior / Tiroir extérieur / Gaveta exterior / Szufłada zewnętrzna

Prof. Depth	Cod.			
350	31904	12	35	1
400	31905	12	35	1
450	31906	12	35	1
500	31907	12	35	1

Steel

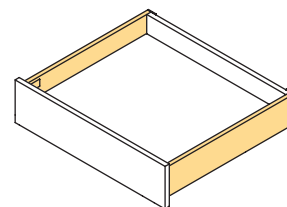
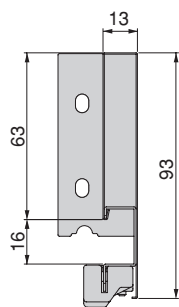

- The code includes all the elements for the assembly of an exterior drawer except the front, back and bottom.
- Includes slides, metal sides and kit of front clip for external drawer.
- Il codice include tutti gli elementi per il montaggio di un cassetto esterno ad eccezione del frontale, la schiena ed il fondo.
- Include guide, fianco e coppia di agganci frontali per cassetto esterno.
- El código incluye todos los elementos para el montaje de un cajón exterior a excepción de la frontera, trasera y fondo.
- Incluye guías, costillas y juego de enganches frontales para cajón exterior.

Exterior drawer / Cassetto esterno / Cajón exterior / Tiroir extérieur / Gaveta exterior / Szuflada zewnętrzna

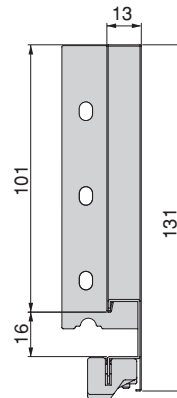

Prof. Depth	Cod.			
350	31911	12	35	1
400	31912	12	35	1
450	31913	12	35	1
500	31914	12	35	1

Steel

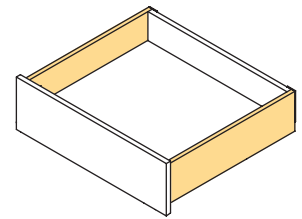

Exterior drawer / Cassetto esterno / Cajón exterior / Tiroir extérieur / Gaveta exterior / Szuflada zewnętrzna

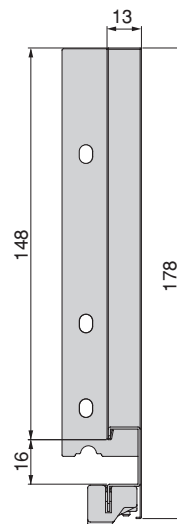

Prof. Depth	Cod.			
350	31915	12	35	1
400	31916	12	35	1
450	31917	12	35	1
500	31918	12	35	1

Steel

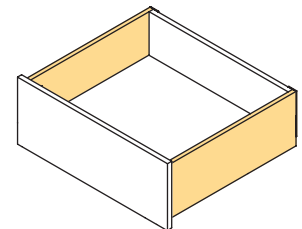

- Chaque kit inclu tous les éléments pour monter un tiroir sauf la façade avant, l'arrière et le fond de tiroir.
- Le kit inclu coulisses, côtés métalliques et jeu d'attaches façade pour tiroir extérieur.
- O código inclui todos os elementos para a montagem de uma gaveta exterior à exceção da frente, traseira e fundo.
- Includi corrediças, laterais e jogo de engates frontais para gaveta.
- Kod zawiera wszystkie elementy do montażu szuflady zewnętrznej z wyjątkiem frontu, tyłu i dna.
- Zawiera prowadnice, metalowe boki, zestaw zacisków frontowych do szuflady zewnętrznej.



12 White painted / Verniciato bianco / Pintado blanco / Peint en blanc / Pintado branco / Malowane na biało
 35 Anthracite grey / Grigio antracite / Gris antracita / Gris antracite / Gris antracite / Szary antracyt

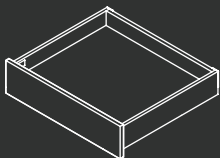

Sides / Fianchi / Costillas / Côtés / Laterais / Boki

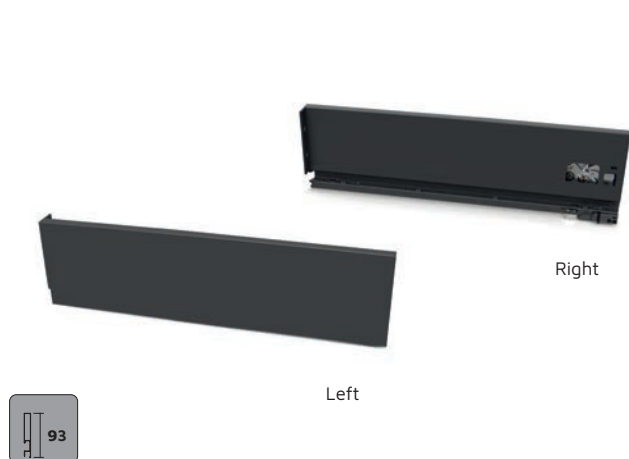

Prof. Depth	Left		Right		
	Cod.	35	Cod.	35	
350	31802	35	31803	35	20
450	31806	35	31807	35	20
500	31808	35	31809	35	20

Steel

Sides / Fianchi / Costillas / Côtés / Laterais / Boki

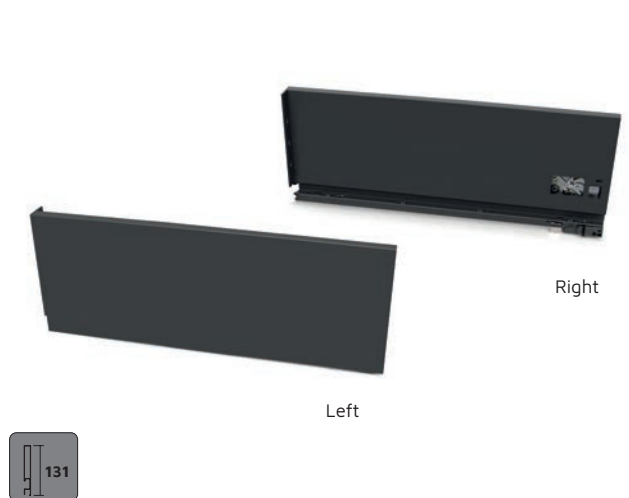

Prof. Depth	Left		Right		
	Cod.	35	Cod.	35	
350	31816	35	31817	35	20
450	31820	35	31821	35	20
500	31822	35	31823	35	20

Steel

Sides / Fianchi / Costillas / Côtés / Laterais / Boki

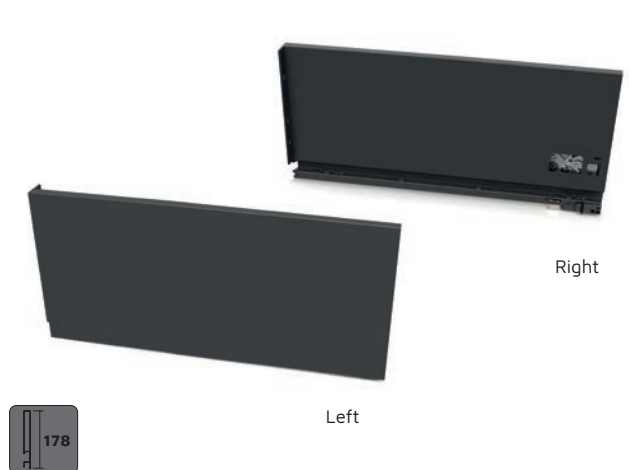



Prof. Depth	Left		Right		
	Cod.	35	Cod.	35	
350	31830	35	31831	35	20
450	31834	35	31835	35	20
500	31836	35	31837	35	20

Steel

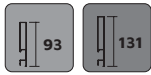
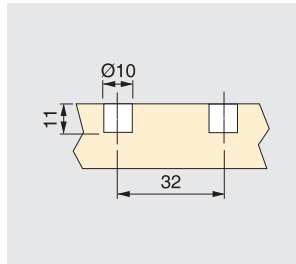
Clips / Agganci / Enganches / Attaches / Engates / Zacisków





Description	Cod. 	
Screw-on	31040 05	100
Knock-in	31041 05	100

Steel

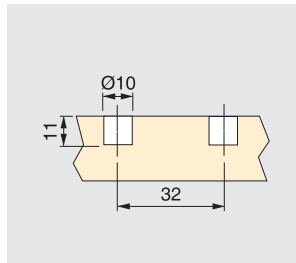
Clips / Agganci / Enganches / Attaches / Engates / Zacisków







Description	Cod. 	
Screw-on	31760 05	50
Knock-in	31761 05	50

Steel

Slides / Guide / Guias / Coulisses / Corrediças / Prowadnice



Prof. Depth	Left		Right		
	Cod. 		Cod. 		
350	31774	05	31775	05	20
450	31778	05	31779	05	20
500	31780	05	31781	05	20

Steel



Railing

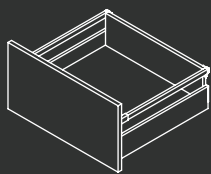

Set of railing / Coppia di astine / Juego de barandillas / Jeu de réhausses / Jogo de cercos / Zestaw bocznego



Prof.	Cod.			
270	31106	12	35	20
300	31101	12	35	20
350	31102	12	35	20
400	31103	12	35	20
450	31104	12	35	20
500	31105	12	35	20
550	31107	12	35	20

Steel

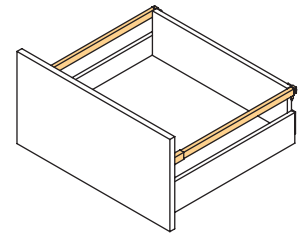

Front fixing / Aggancio frontale / Enganche frontal / Fixation frontale / Engate frontal / Przykręcany frontowy

Cod.		
31100	21	40

Plastic



- For timber fronts we recommend Ø3,5 mm screws.
- Per frontalini in legno si raccomanda utilizzare viti Ø3,5 mm.
- Para frentes de madera se recomienda tornillo de Ø3,5 mm.
- Pour façade en bois nous conseillons Ø3,5 mm.
- Para frentes de madeira recomenda-se o parafuso Ø3,5 mm.
- Dla frontów z drewna zalecamy śruby Ø3,5 mm.

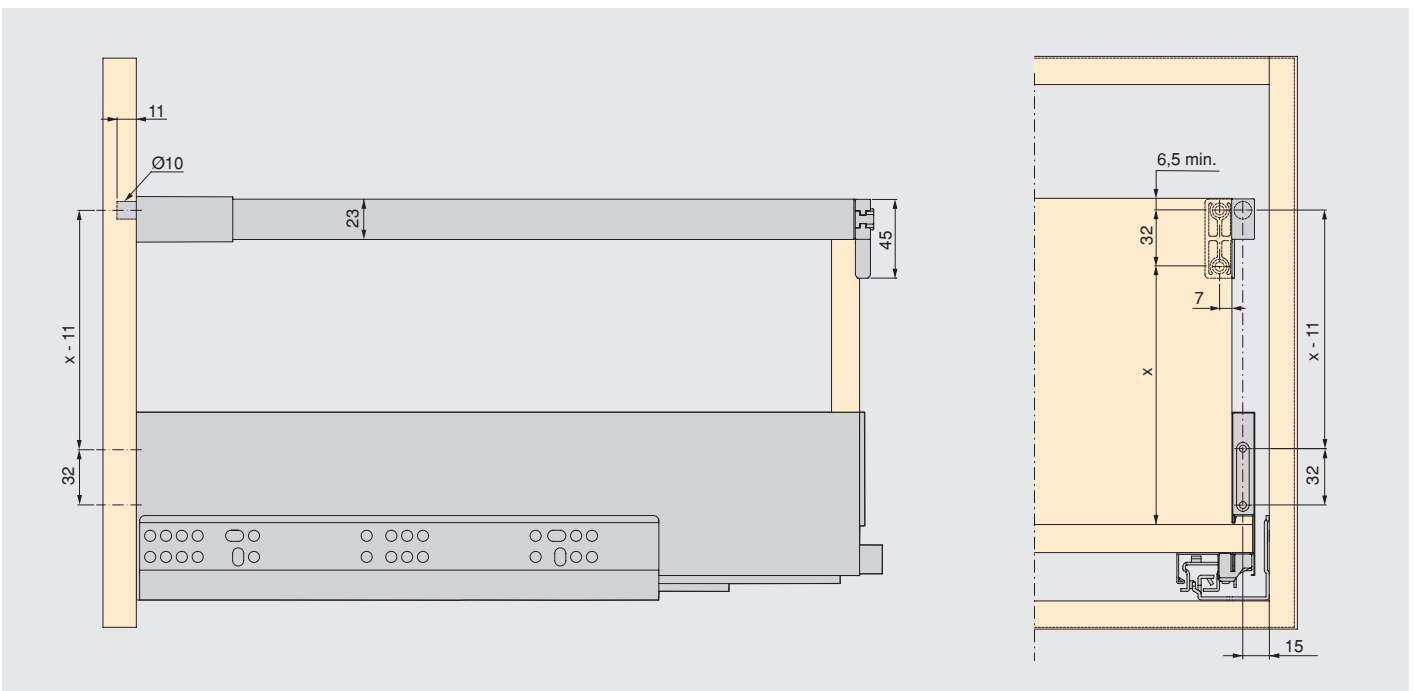

12 White painted / Verniciato bianco / Pintado blanco / Peint en blanc / Pintado branco / Malowane na biało
 21 Grey plastic / Plastica grigia / Plástico gris / Plastique gris / Plástico cinza / Szary plastik
 35 Anthracite grey / Grigio antracite / Gris antracita / Gris antracite / Gris antracite / Szary antrycyt

Inner
drawer

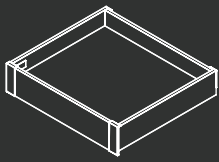

Set of fittings / Coppia di agganci / Juego de enganches / Jeu d'attaches / Jogo de engates / Zestaw frontowych

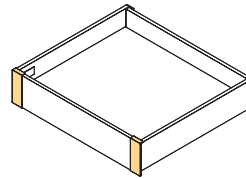

H	Cod.			
83	31720	15	23	4

Plastic

Set of fittings / Coppia di agganci / Juego de enganches / Jeu d'attaches / Jogo de engates / Zestaw frontowych

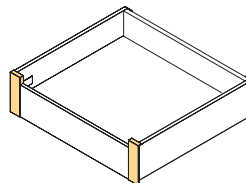

H	Cod.			
93	31721	15	23	4

Plastic

Set of fittings / Coppia di agganci / Juego de enganches / Jeu d'attaches / Jogo de engates / Zestaw frontowych

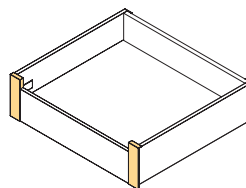

H	Cod.			
131	31722	15	23	4

Plastic

Set of fittings / Coppia di agganci / Juego de enganches / Jeu d'attaches / Jogo de engates / Zestaw frontowych

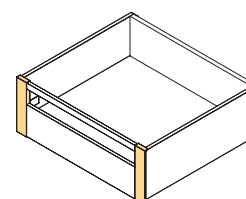

H	Cod.			
178	31723	15	23	4

Plastic



15 White plastic / Plastica bianca / Plástico blanco / Plastique blanc / Plástico branco / Biały plastik

23 Anthracite grey plastic / Plastica grigio antracite / Plástico gris antracita / Plastique gris antracite / Plástico gris antracite / Szary antracytowy plastik

Inner
drawer

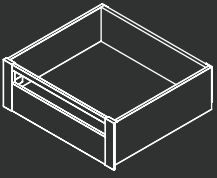

Frontal railing / Astina frontale / Barandilla frontal / Réhausse frontale / Cerco frontal / Reling frontowy

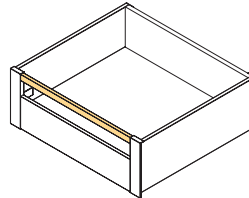
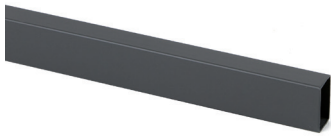

H		Cod.		
178	1,12 m	31134	12 35	10

Aluminium

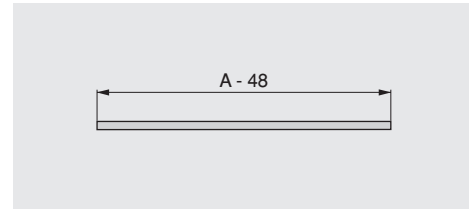

A= Module inner size / Interno modulo / Interior módulo / Interieur caisson / Interior de módulo / Rozmiar wewnętrzny modułu

Frontal profile / Profilo frontale / Perfil frontal / Profil frontal / Perfil frontal / Profil frontowy

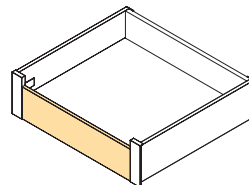
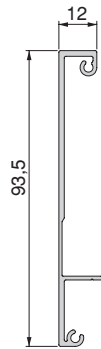
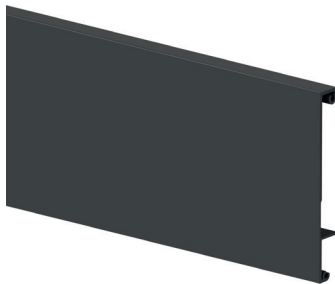

	Cod.		
1,10 m	31724	12 35	10

Aluminium

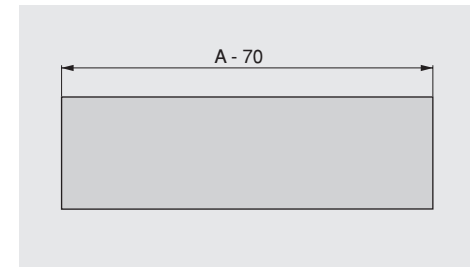

A= Module inner size / Interno modulo / Interior módulo / Interieur caisson / Interior de módulo / Rozmiar wewnętrzny modułu

Lateral spacers / Distanziale laterale / Distanciadores laterales / Séparateurs latéraux / Distanciadores laterais / Podkładki dystansowe

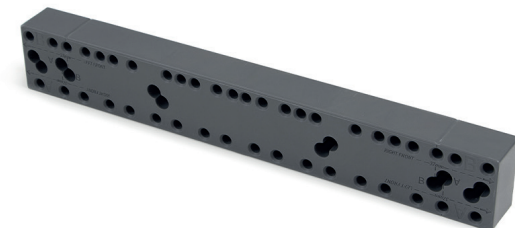

- Allows assembly with hinged doors. Includes Euro screws.
- Permette di montaggio con porte incernierate. Include viti Euro.
- Permite el montaje con puertas abisagradas. Incluye tornillos Euro.
- Permet le montage avec des portes à charnières. Comprend des Eurovis.
- Permite a montagem com portas com dobradiças. Inclui parafusos Euro.
- Umożliwia montaż drzwi z zawiasami. Zawiera eurowkręty.

Cod.		
31108	15 23	4

Plastic

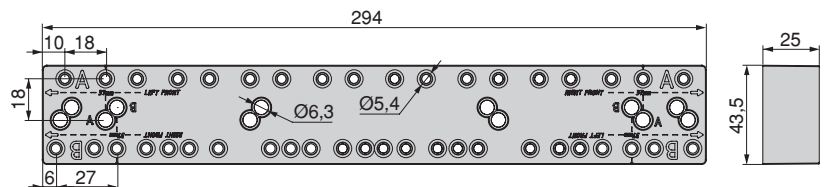

- 12 White painted / Verniciato bianco / Pintado blanco / Peint en blanc / Pintado branco / Malowane na biało
- 15 White plastic / Plastica bianca / Plástico blanco / Plastique blanc / Plástico branco / Biały plastik
- 35 Anthracite grey / Grigio antracite / Gris antracita / Gris antracite / Gris antracite / Szary antrycyt
- 23 Anthracite grey plastic / Plastica grigio antracite / Plástico gris antracite / Plastique gris antracite / Plástico gris antracite / Szary antrycytowy plastik

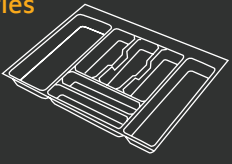

Cutlery trays / Portaposate / Cuberteros / Range-couverts / Porta-talheres / Wkłady szufladowe

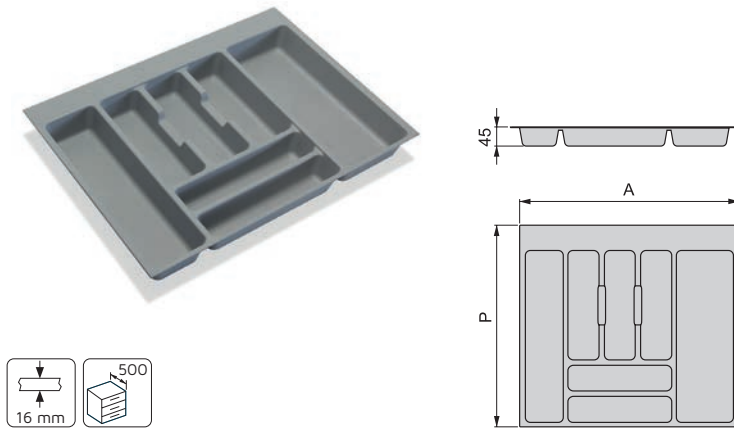

Modul	A	P	Cod.			
300	222	473	83268	15	-	10
350	272	473	83269	15	-	10
400	322	473	83258	15	23	20
450	372	473	83259	15	23	20
500	422	473	83260	15	23	20
600	522	473	83261	15	23	20
700	622	473	83262	15	23	10
800	722	473	83263	15	23	10
900	822	473	83264	15	23	10
1.000	922	473	83265	15	23	10
1.200	1.122	473	83266	15	23	10

Plastic

Template to fix / Sagoma di foratura / Juego de plantillas / Jeu de gabarits / Jogo de bitolas / Szablon do mocowania

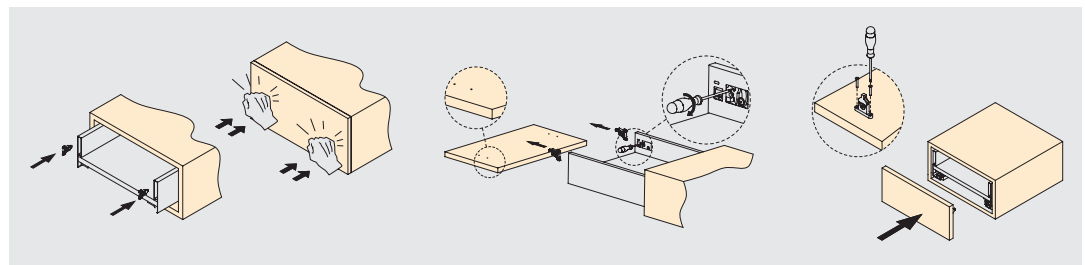

Cod.		
31140	21	1

Plastic

Lokbox union / Unione Lokbox / Unión Lokbox / Union Lokbox / União Lokbox / Łącznik Lokbox



Cod.		
30026	21	20

Plastic

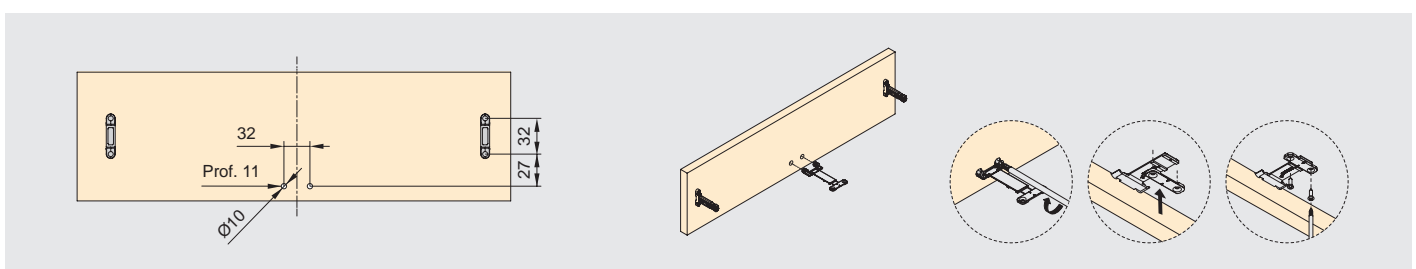

15 White plastic / Plastica bianca / Plástico blanco / Plastique blanc / Plástico branco / Biały plastik

21 Grey plastic / Plastica grigia / Plástico gris / Plastique gris / Plástico cinza / Szary plastik

23 Anthracite grey plastic / Plastica grigio antracite / Plástico gris antracita / Plastique gris antracite / Plástico gris antracite / Szary antracytowy plastik

Under-sink
insert

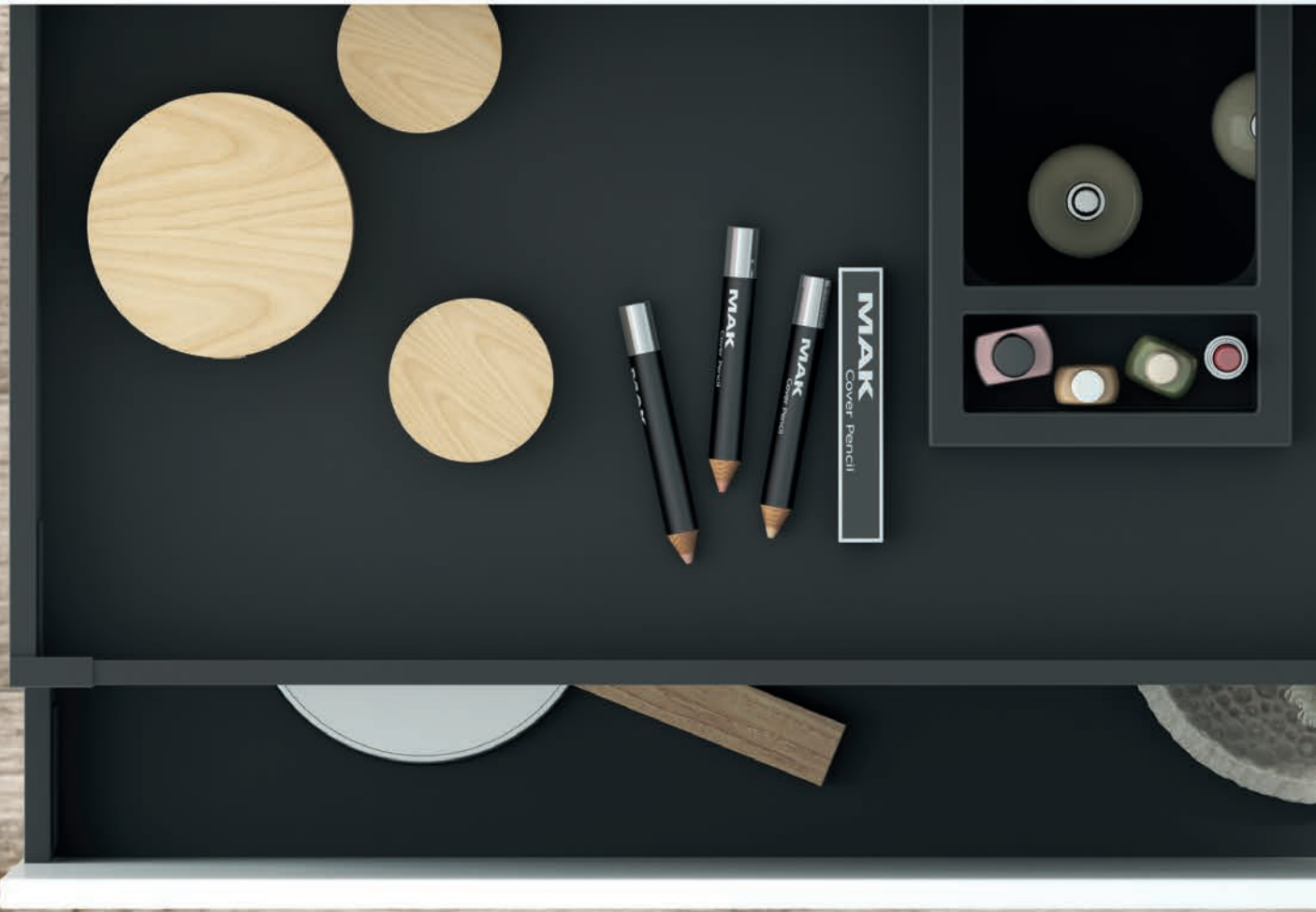
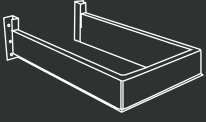

Under-sink insert / Schiena sagomata / Bajo fregadero / Sous-évier / Salva-sifão / Wstawka podumywalkowa

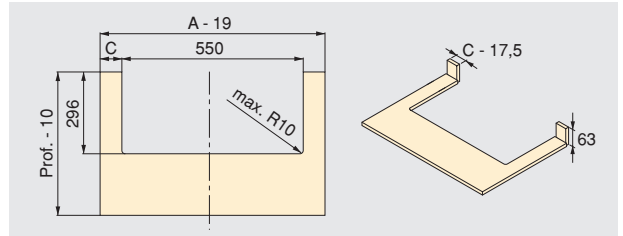
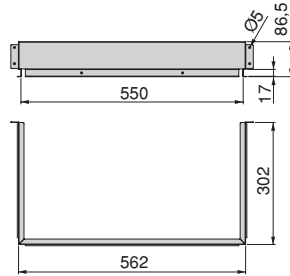

Cod.		
30179	12	35
		10

Aluminium

Under-sink insert / Salva sifone / Salva sifón / Sous-évier / Salva-sifão / Prostokątna wstawka

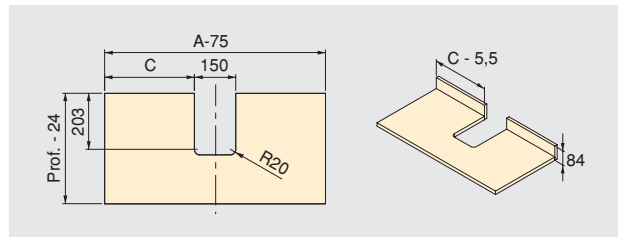
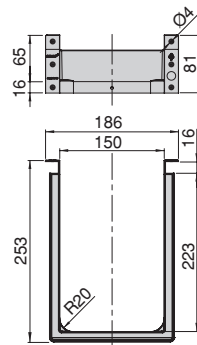

Cod.		
30444	15	23
		10

Plastic

Under-sink insert / Salva sifone / Salva sifón / Sous-évier / Salva-sifão / Prostokątna wstawka

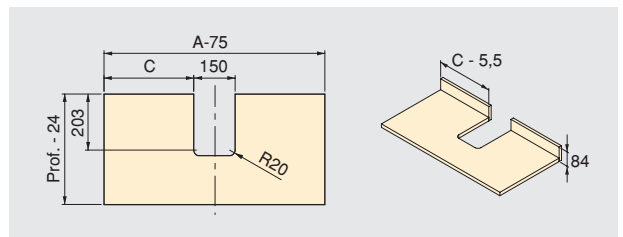
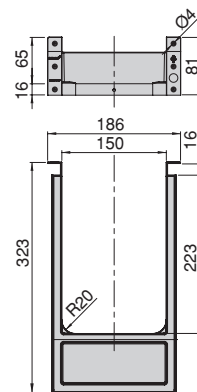

Cod.		
30441	15	23
		6

Plastic

Under-sink insert / Salva sifone / Salva sifón / Sous-évier / Salva-sifão / Prostokątna wstawka

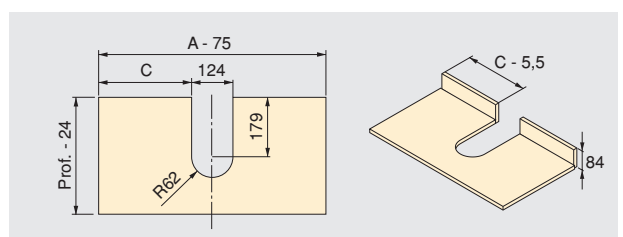
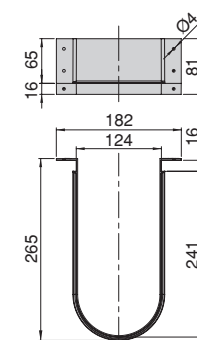

Cod.		
30443	15	23
		10

30444	15	23
		80

Plastic

- 12 White painted / Verniciato bianco / Pintado blanco / Peint en blanc / Pintado branco / Malowane na biało
- 15 White plastic / Plastica bianca / Plástico blanco / Plastique blanc / Plástico branco / Biały plastik
- 35 Anthracite grey / Grigio antracite / Gris antracita / Gris antracite / Szary antracyt
- 23 Anthracite grey plastic / Plastica grigio antracite / Plástico gris antracita / Plastique gris antracite / Szary antracytowy plastik

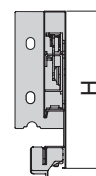
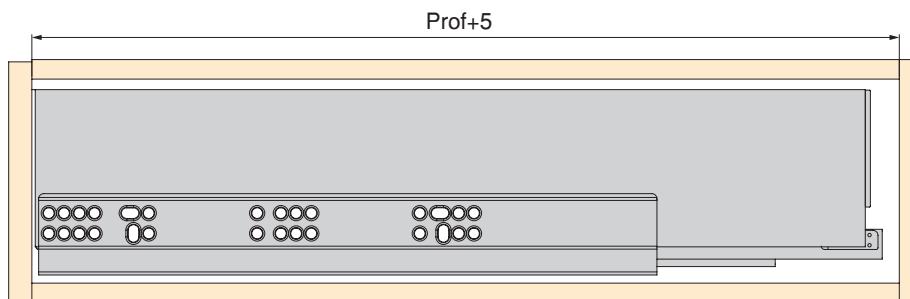
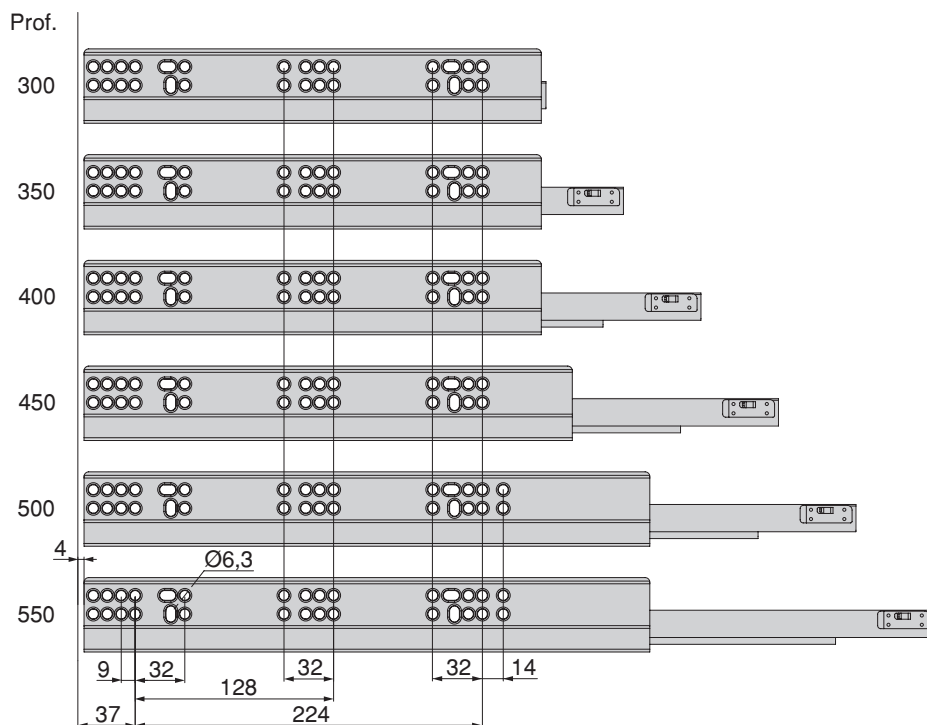
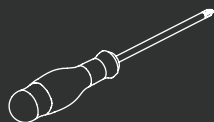

H
83
93
131
178

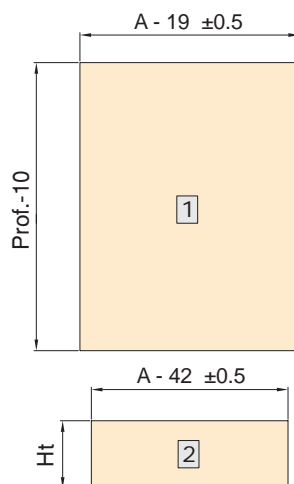
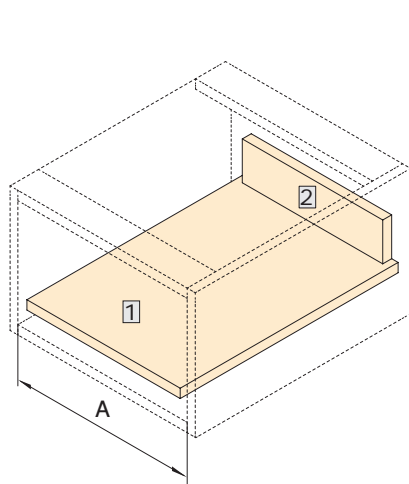

H	Ht
83	53
93	63
131	101
178	148

Assembly

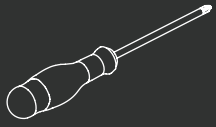

Adjustment / Regolazione / Regulación / Réglage / Regulação / Dostosowanie

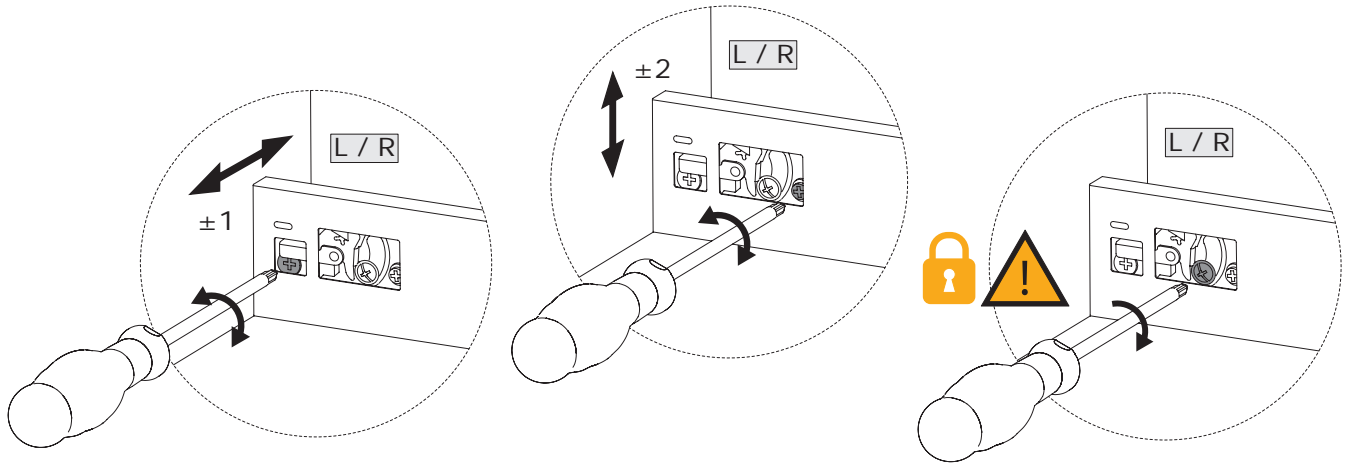

Dismounting / Smontaggio / Desmontaje / Démontage / Desmontagem / Demontaž

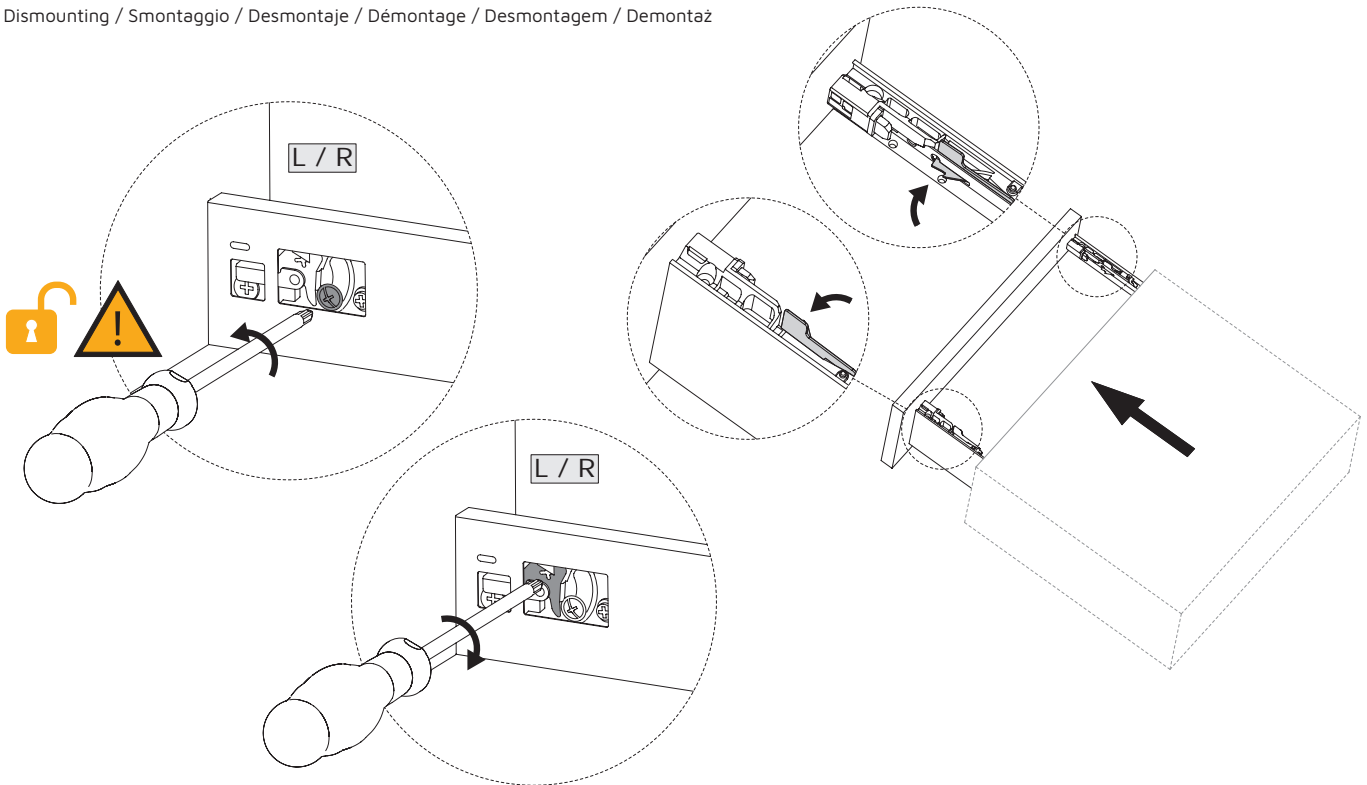

Adjustment tilt front / Regolazione de l'inclinazione del frontale / Ajuste inclinación frente / Réglage de la façade / Regulação frente/ Prząd regulacji nachylenia

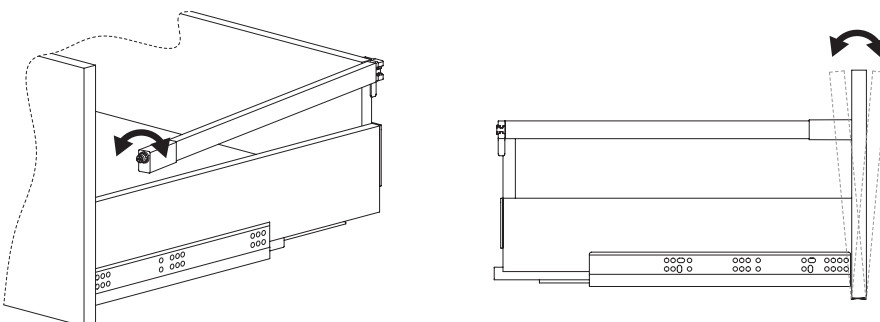



furniture fittings solutions



Emuca S.R.L.

Via Messico, 80 • 35127 Padova (ITALIA)
T. +39 049 8702800 • F. +39 049 87 03019
www.emuca.it • info@emuca.com

Emuca Ltd.

75 Springfield Road • Chelmsford • Essex • CM2 6JG (UK)
T. +44 1268 530 674 • F. +44 1268 282 592
www.emuca.co.uk • sales@emuca.com

Emuca S.A.

Pl. El Oliveral - c/H, 4 • Apartado de correos 176
46394 Ribà-Roja del Túria • Valencia (ESPAÑA)
T. +34 96 166 70 19 • F. +34 96 166 71 82
www.emuca.es • emuca@emuca.com

Emuca S.A.R.L

Parc de l'Aubinière • 2 Avenue des Améthystes
44338 Nantes Cedex 03 (FRANCE)
T. +33 2 49 88 07 35 • F. +33 2 72 22 02 24
www.emuca.fr • emuca@emuca.com

Emuca Lda.

AV. da Liberdade n° 36, 6° • 1250-145 Lisboa (PORTUGAL)
T. +351 211 203 940 • F. +34 96 166 71 82
www.emuca.pt • emuca@emuca.com

