

# MIKA

FICHA TÉCNICA  
DATA SHEET



**kendo**

# kendo

## MIKA

Yembarastudio

Colección de mesas de centro y auxiliares compuesta por una tapa superior circular en MDF acabado en chapa de roble o laca. La tapa inferior está disponible en MDF acabado en chapa de roble, nogal o laca. La estructura es de metal termolacado negro microtexturado. \*En la medida de 120x45 la tapa superior también puede ser en MDF acabado en chapa de nogal.

Collection of coffee and occasional tables comprising circular top in lacquered MDF or in oak veneer. The inferior top in lacquered MDF or in oak or walnut veneer. With a micro-textured black thermo-lacquered metal structure. \* In 120x45 size, the superior top can also be made of walnut veneered MDF.

### Mesas auxiliares Occasional tables

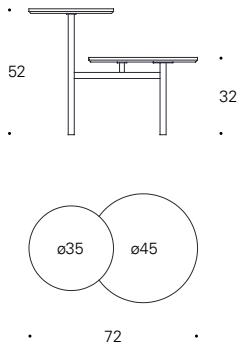

MIK-74

72x45x52 cm

0,242 m<sup>3</sup> 9 Kg

Tapa inferior laca / Estructura termolacada negro microtexturado  
Lacquer inferior top / Micro-textured black thermo-lacquered structure

Tapa inferior roble / Estructura termolacada negro microtexturado  
Oak inferior top / Micro-textured black thermo-lacquered structure

Tapa inferior nogal / Estructura termolacada negro microtexturado  
Walnut inferior top / Micro-textured black thermo-lacquered structure

Acabado tapa superior: Laca / Roble  
Superior top finish: Lacquer / Oak

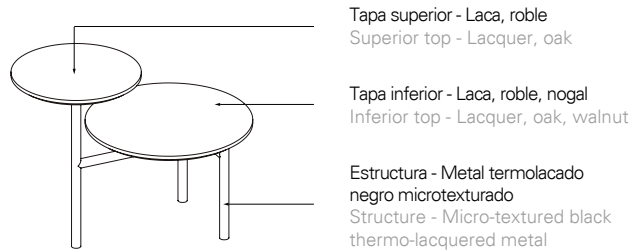

### Mesas de centro Coffee tables

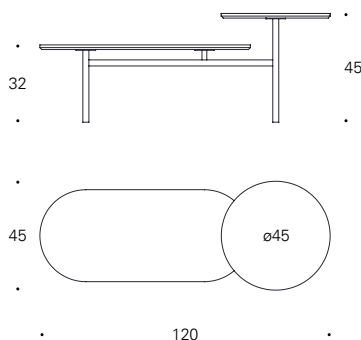

MIK-24

120x45x45 cm

0,343 m<sup>3</sup> 15 Kg

Tapa inferior laca / Estructura termolacada negro microtexturado  
Lacquer inferior top / Micro-textured black thermo-lacquered structure

Tapa inferior roble / Estructura termolacada negro microtexturado  
Oak inferior top / Micro-textured black thermo-lacquered structure

Tapa inferior nogal / Estructura termolacada negro microtexturado  
Walnut inferior top / Micro-textured black thermo-lacquered structure

Acabado tapa superior: Laca / Roble / Nogal  
Superior top finish: Lacquer / Oak / Walnut

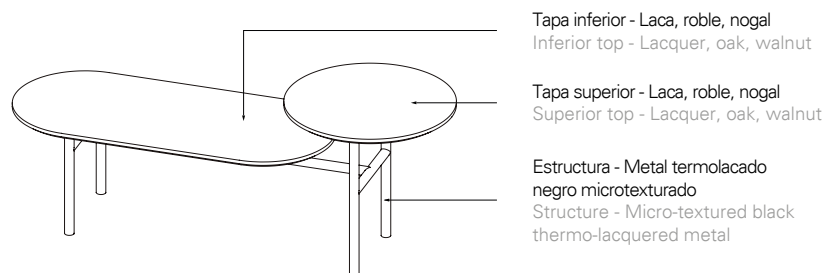

# ACABADOS FINISHES

Colores aproximados  
Approximate colours

## MADERA | WOOD



**Roble natural**  
Natural oak

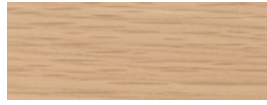

**Roble claro**  
Light oak

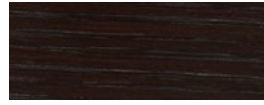

**Roble teñido wengue**  
Wengue stained oak

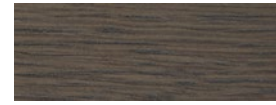

**Roble teñido ceniza**  
Ash stained oak



**Roble teñido tostado**  
Toasted stained oak



**Nogal natural**  
Natural walnut

## LACA MATE | MATT LACQUER



**Piedra**  
Stone  
—  
RAL 7044



**Arena**  
Sand  
—  
NCS S2005-Y20R



**Visión**  
Taupe  
—  
NCS S4005-Y20R



**Grafito**  
Graphite  
—  
RAL 7022



**Niebla**  
Fog  
—  
NCS S5005-B20G



**Océano**  
Ocean  
—  
NCS S7010 B10G



**Pizarra**  
Slate  
—  
NCS S8500-N



**Negro**  
Black  
—

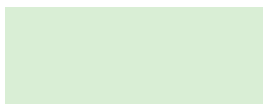

**Menta**  
Mint  
—  
NCS S3010 G20Y



**Oliva**  
Olive  
—  
NCS S6010 G10Y



**Bosque**  
Forest  
—  
NCS S7010-B90G



**Blanco**  
White  
—



**Teja**  
Tile  
—  
NCS S5030 Y90R

Opcionalmente se pueden solicitar otros colores de laca referenciados según la carta RAL o carta NCS.

Alternatively you can request other colours of lacquer referenced according to RAL or NCS card.