

NARUK

FICHA TÉCNICA
DATA SHEET



kendo

kendo

NARUK

Vicente Gallega

Colección de escritorios realizada en tablero de MDF acabado en chapa de nogal, roble o laca. En la parte inferior de la tapa cuenta con un cajón extraíble integrado en el conjunto, con un hueco útil de 65x32x4 cm. También se oferta el escritorio sin cajón.

Collection of desks made in lacquered MDF, veneered in walnut or oak. Underside of the top has a removable drawer integrated in the structure, with a useful drawer space of 65x32x4 cm. It is also available without drawer.

Escritorios

Desks

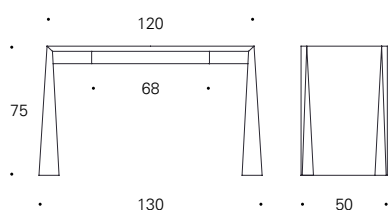

NP-35	Con cajón With drawer	130x50x75 cm	0,656 m ³	38 Kg
Nogal Walnut				
Roble Oak				
Laca Lacquer				

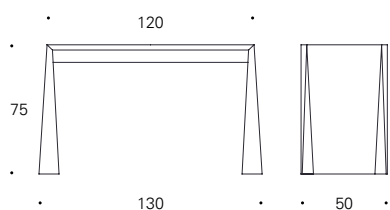

NP-35SC	Sin cajón Without drawer	130x50x75 cm	0,656 m ³	36 Kg
Nogal Walnut				
Roble Oak				
Laca Lacquer				

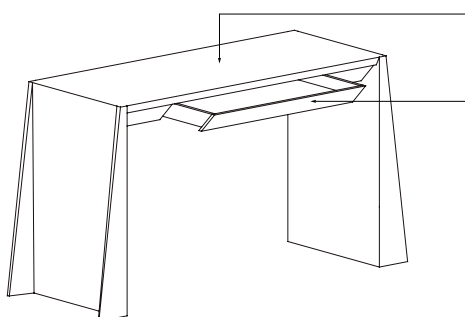

Laca, roble, nogal
Lacquer, oak, walnut

El cajón tiene un hueco útil de 65x32x4 cm
The drawer has space of 65x32x4 cm

ACABADOS FINISHES

Colores aproximados
Approximate colours

MADERA | WOOD



Roble natural
Natural oak



Roble claro
Light oak

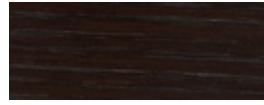

Roble teñido wengue
Wengue stained oak

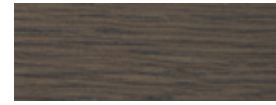

Roble teñido ceniza
Ash stained oak

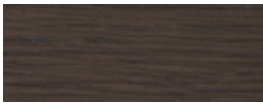

Roble teñido tostado
Toasted stained oak



Nogal natural
Natural walnut

LACA MATE | MATT LACQUER



Piedra
Stone
—
RAL 7044



Arena
Sand
—
NCS S2005-Y20R



Visión
Taupe
—
NCS S4005-Y20R



Grafito
Graphite
—
RAL 7022



Niebla
Fog
—
NCS S5005-B20G



Océano
Ocean
—
NCS S7010 B10G



Pizarra
Slate
—
NCS S8500-N



Negro
Black
—

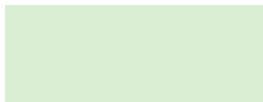

Menta
Mint
—
NCS S3010 G20Y



Oliva
Olive
—
NCS S6010 G10Y



Bosque
Forest
—
NCS S7010-B90G

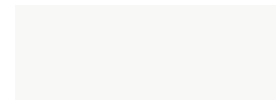

Blanco
White
—



Teja
Tile
—
NCS S5030 Y90R

Opcionalmente se pueden solicitar otros colores de laca referenciados según la carta RAL o carta NCS.

Alternatively you can request other colours of lacquer referenced according to RAL or NCS card.