

viccarbe

Savina

Designed by Victor Carrasco

Catalogue - EN



Victor Carrasco

Born in Valencia (Spain) in 1974, Victor Carrasco began his professional career after graduating Cum Laude in Industrial Design Engineering at the Polytechnic University of Valencia.

Far from fashions and trends, he develops and puts international brands in the center, with remarkable added value, thanks to his passion for synthesis, sustainable growth and his pragmatic vision of the future.

Founder and Strategic Director at Viccarbe, a role that he combines since 2007, with being one of the counselors of STEELCASE, the prestigious American multinational company, he also collaborates with many other renowned brands.

Throughout his career, he has been honored with the Principe Felipe Award for Entrepreneurial Excellence and awarded with the German Design Award.

SAVINA

Island of collaboration

A sofa designed by Victor Carrasco, 2022

2022 — Savina joins our collection of ancillary furniture to enhance soft collaboration. An innovative sofa that presents a new universe of comfortable working solutions for every office, workplace, home, hospitality area or hybrid space.

Due to its soothing silhouette and its infinite compositions, we like to call it an island of collaboration, a reassuring spot to gather, work and retreat. An original, flexible and mindful sitting concept for hybrid spaces to nurture synergy, creativity, productivity, and well-being.

Get immersed and transport yourself into the era of soft collaborative comfort with Savina. This is Savina.



Savina takes its name from the natural entrance to the island of Formentera

Savina takes its name from the natural entrance to the island of Formentera in Spain. This island is possibly one of the most serene places in the Mediterranean that connects you with nature and makes you unwind. This pleasant feeling of relaxation is what we wanted to recreate when sitting on a Savina sofa.



Featuring Savina with chaise longue, matching cushions and upholstered arm.



With Savina we wanted to fulfil one of our maxims: designing the most comfortable modular sofa that reinterpreted to perfection the feeling of sitting on a cloud and the relaxing sensation of floating on water. A collaborative island that conveyed both visual and physical comfort, with a more holistic approach, where the entire human routines have been considered to bring the most pleasant working experience.



Featuring Savina sofa with different modules, auxiliary tables and matching cushions.

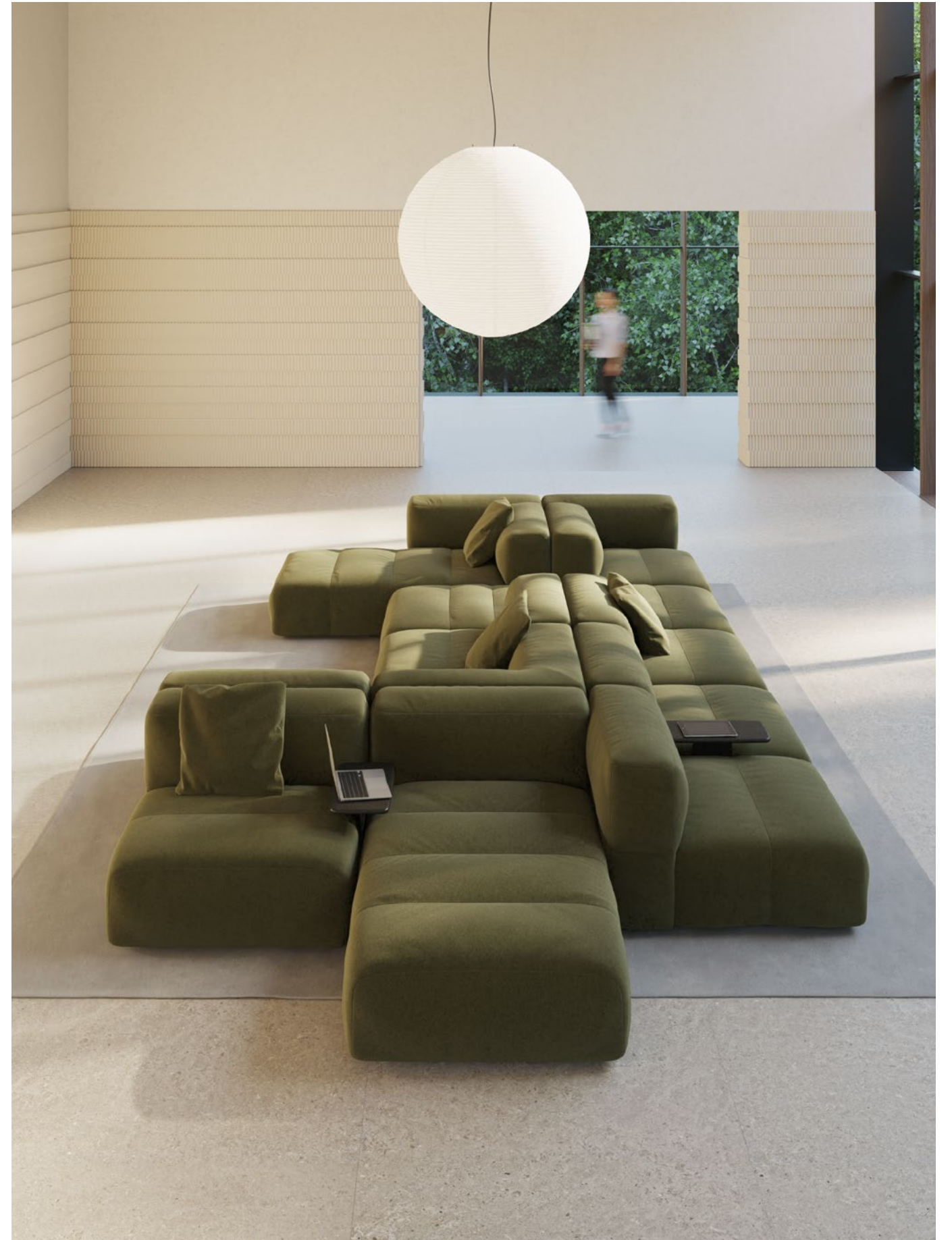

The new Savina module
maintains its essence while
multiplying its possibilities
for all users



SAVINA 140

We have increased the versatility of the Savina sofa through a new, larger, and wider module, offering multiple solutions especially designed for collaborative spaces, without compromising its enveloping and welcoming silhouette.

With this new version, Savina offers greater capacity with fewer modules, making it ideal for waiting rooms, receptions, intermediate zones, and collaborative areas. At the same time, it promotes comfort and concentration, inviting the user to remain seated for hours and facilitating the exchange of ideas, always essential to encourage teamwork.

Savina sofa with different modules,
an armrest and cushion

Featuring Savina lounge chair
and Savina sofa



Infinite modularity with ease of movement, agility and comfort



With hidden casters.
Pure dynamism.



Savina Chaise

"The independent chaise invites you to work for hours, exchanging ideas, working solo or in teams."

Harmony, comfort, and productivity. The new Savina Chaise leads to comfortable working and represents a new way of appreciating the ordinary. A versatile piece with casters, that encourages serenity and focus whilst performing the daily tasks. Savina invites you to sit for hours, exchanging ideas, working solo or in teams.



A versatile chaise with casters to focus whilst performing the daily tasks. Designed to last



Featuring Savina Chaise with wooden table and technical fabric for extra resistance, designed to last.



CONNECTIVITY & MOBILITY

Connectivity is sorted thanks to its useful electrification options and its hidden casters add freedom of movement.

SAVINA & WORK

Working on a chaise longue has multiple benefits for the mind and soul. A practical and comfortable addition to places that seek a special seat for visitors, and workers to perform, relax and unwind. A piece that makes a great use of the space available and conveys a welcoming spot when looking for inspiration.

MULTIPLE OPTIONS TO CHOOSE FROM

Savina Chaise has multiple options: includes hidden casters, making it easy to place it anywhere and to create infinite combinations depending on the situation, accessories such as wooden tables, great when working on the laptop, arranging a videocall or enjoying a quick coffee, and discreet integrated electrifications, solving problems of connectivity when working away from the usual desk.

TECHNICAL FABRIC AT FOOT HEIGHT TO INCREASE DURABILITY

Mix and match different fabrics to achieve a bespoke chaise longue to work all day long. The technical fabric at foot height **brings extra resistance and durability**, adding a modern and relaxed aesthetic to the design. A good option for high-traffic areas: airports, hotel lobbies or staff breakrooms. Made to last.

The seating solutions are endless with Savina. Personalize it following your taste and needs with total freedom. The corner module amplifies its options, creating a comfortable composition to sit everyone in the room.



Featuring Savina sofa with corner module, matching cushions, auxiliary tables, and integrated electrification.

The soft silhouette of Savina
is the perfect balance between
visual and physical comfort

A comfortable sofa for every space, situation and moment. Savina invites you to sit on it for hours, ideal for collaborative spaces but performs at home too.



Ultimately designed to encourage users to engage with others

SAVINA & EDUCATION

Savina brings ultimate comfort to educational centers, enabling students to feel comfortable during reading, studying or leisure time. A sofa created to foster collaboration, ultimately designed to encourage users to engage with others. Perfect to greet visitors and enhance receptions and lounge areas too.



Connectivity



1. Seat socket
2. Power socket, upholstered
3. Powerbox under table



SAVINA & OFFICE

Cleverly designed, Savina is a multi-purpose modular seating system that works in offices and corporate environments, allowing workers to easily rearrange compositions and move it around thanks to its functional hidden casters. An all-rounder that adapts to any workspace scenery effortlessly.

Configure your own Savina sofa

Discover its components



Creating your own Savina sofa is easy, follow these simple steps to find the best match for your space:

1. Choose your favorite modules
2. Choose the upholstery from our graded-in collections (Fabric, leather, eco-leather,) [Check here our selection fabrics.](#)
3. If required, choose the finish for the arms
4. Accessories: tables, cushions, electrifications...
5. Add hidden casters for unlimited versatility and freedom.

1 Modules

- A. Backless module
- B. Medium backrest module
- C. End module
- D. Corner module
- E. Chaise

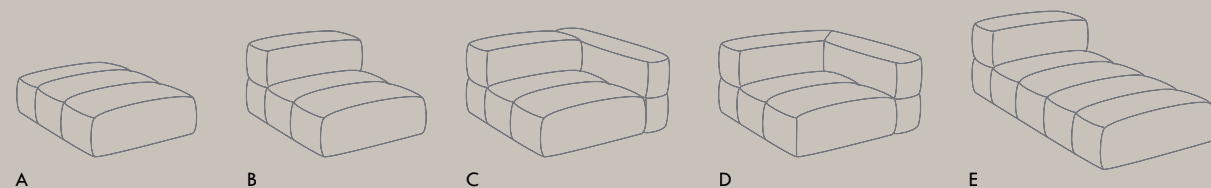

2 Arms

- F. Upholstered arm
- G. End upholstered arm

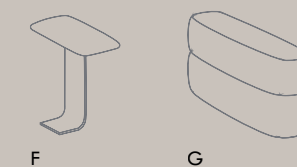

3 Accessories

- H. Table
- I. Cushions

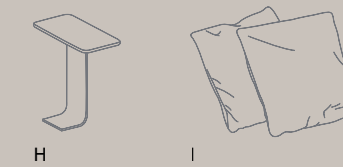

4 Fixed component

- J. Hidden casters

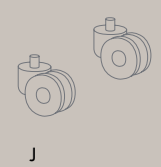



Featuring Savina sofa with different modules, upholstered auxiliary tables, integrated electrifications and matching cushions.



DESIGNED FOR SUSTAINABILITY

"We have created a recyclable sofa, made with as many components as possible from recycled materials. A living project that will be updated as we continue to strive in recycling innovation."



For us there is nothing more sustainable than creating pieces that will last a lifetime. Pieces that will be part of our journey and will be present in our everyday. Everything we make must be meaningful for the environment and for our lives.

With the clear purpose of leading the way into a more sustainable design industry, with Savina we wanted to go a step further. We pursued a recyclable sofa, made with as many components as possible from recycled materials. A living project that will be updated and renewed as we continue to strive in recycling innovation. We also desired a sofa that was pure comfort, both visually and physically, and invited users to sit on

it for hours, collaborating, sharing thoughts, or just relaxing. Our "design for sustainability" ethos focuses on implementing changes in our collections, that prioritize the environment and foster conscious consumption habits. We have attained a recycled sofa that respects the user's requirements of space, use and function. A flexible sofa that works in any type of environment and contributes to a more respectful design industry. Therefore, we stand to innovate and bring conscious practices into our sector that will lead the change in how we perceive design. We create designs to last.

Illustration showcasing the different components that shape Savina.

Fabrics

Choose your favorite upholstery from our collection.

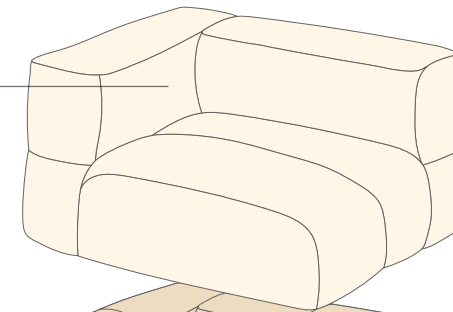

Feathers

RDS certified down fill.

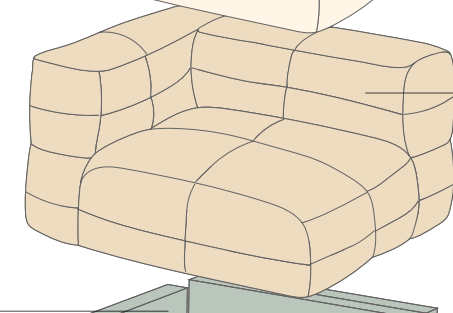

Recyclable foam

Recyclable, non-deformable expanded polyurethane foam of different densities by Recipur.

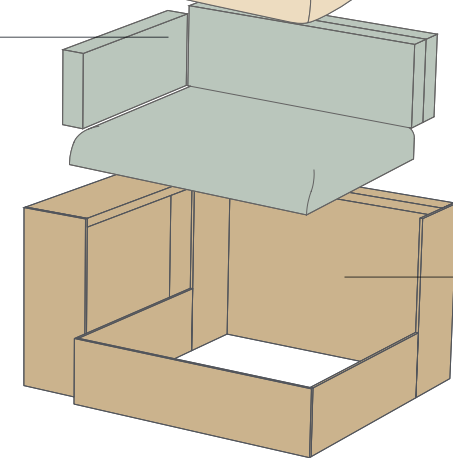

Recycled foam

Medium density recycled polyurethane foam.

Springs

Frame and springs made of high-strength and flexible steel made with recycled materials.

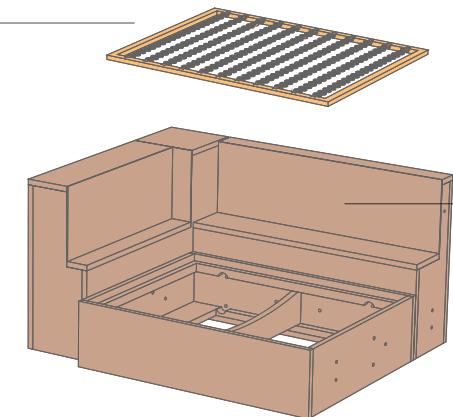

Frame

Solid wood structure from controlled timber with PEFC and FSC certifications.

Casters

Freedom of movement thanks to its discreet hidden casters.

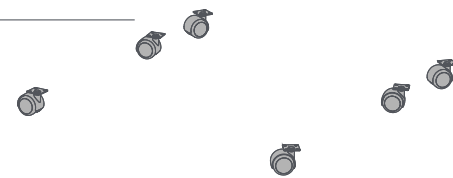

Savina sofa



Savina sofa, Composition 1



Savina sofa, Composition 2



Savina sofa, Composition 3



Savina sofa, Composition 4



Savina sofa, Composition 5



Savina sofa, Composition 6



Savina sofa, Composition 7



Savina sofa, Composition 8



Savina sofa, Composition 9



Savina sofa, Composition 10



Savina sofa, Composition 11

&lounge chair



Savina sofa, Composition 19



Savina sofa, Composition 20



Savina sofa, Composition 21



Savina sofa, Composition 4



Savina sofa, Composition 22



Savina sofa, Composition 23



Savina sofa, Composition 24

Connectivity



1. Seat socket
2. Power socket, upholstered
3. Powerbox under table

viccarbe

SAVINA SOFA - MODULES

SAVIM
module

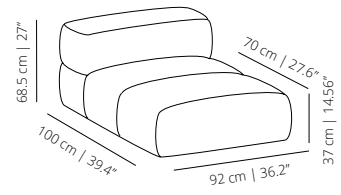

SAVIMA
module

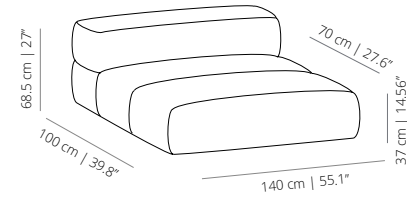

SAVICH
chaise module

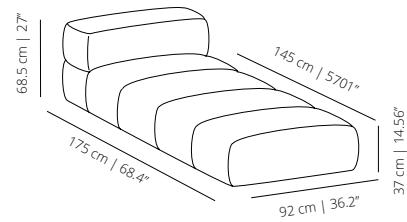

SAVIRI
corner module

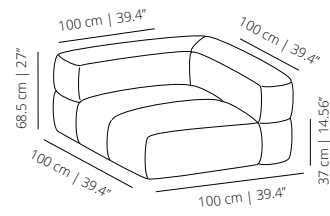

SAVISR
pouf

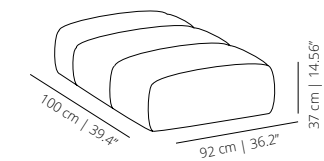

SAVIPO
pouf

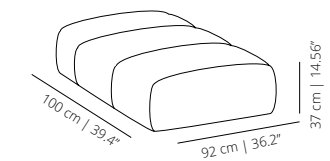

SAVIBRHT
upholstered arm

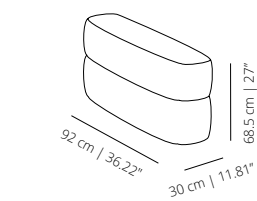

SAVIBRRO
upholstered wooden arm

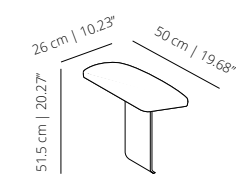

SAVINA SOFA - COMPOSITIONS

COMPOSITION 1
loung chair

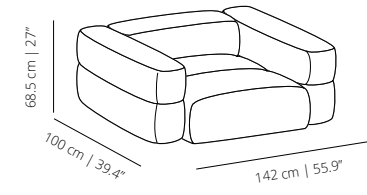

COMPOSITION 2
chaise longue

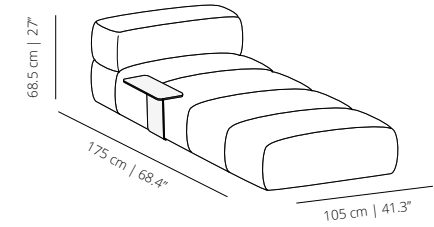

COMPOSITION 3
sofa

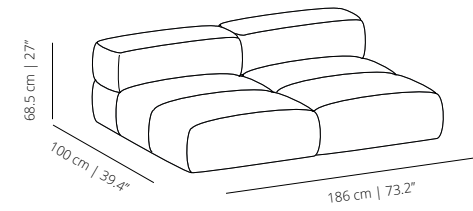

COMPOSITION 4
sofa

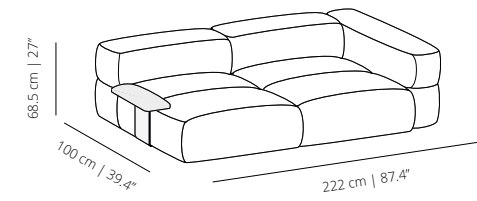

COMPOSITION 5
sofa

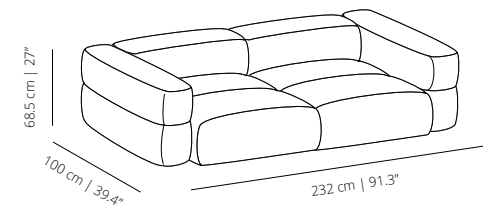

COMPOSITION 6
sofa

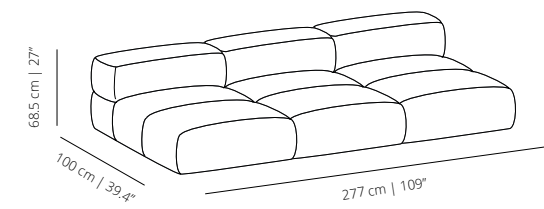

COMPOSITION 7
sofa

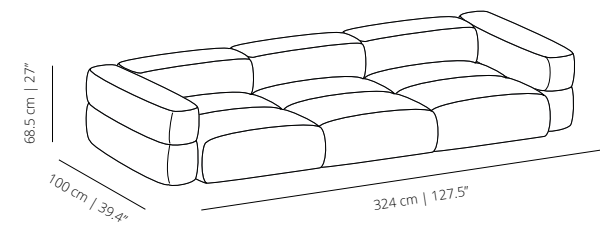

COMPOSITION 8
sofa

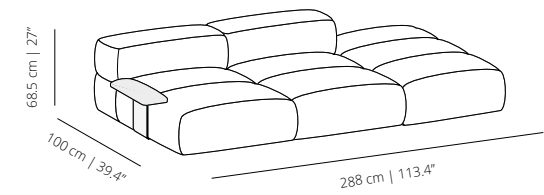

SAVINA SOFA - COMPOSITIONS

COMPOSITION 9
sofa

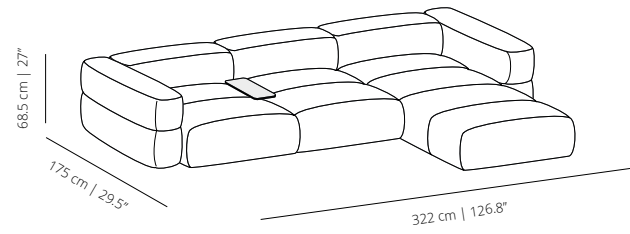

COMPOSITION 10
sofa

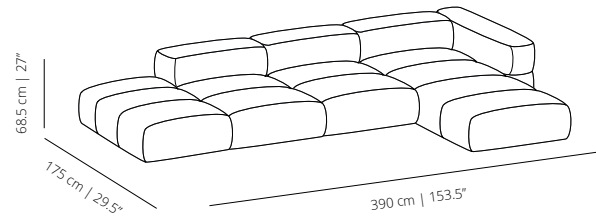

COMPOSITION 11
sofa

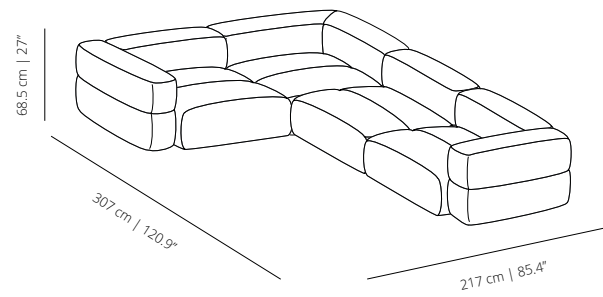

COMPOSITION 12
sofa

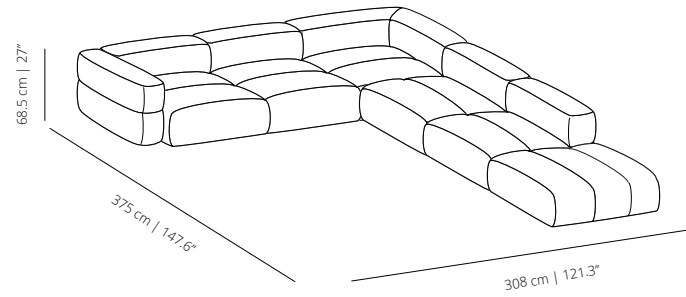

COMPOSITION 13
armchair

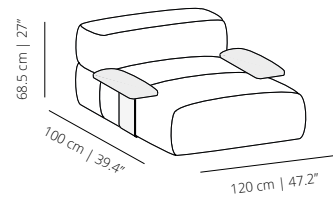

COMPOSITION 14
sofa

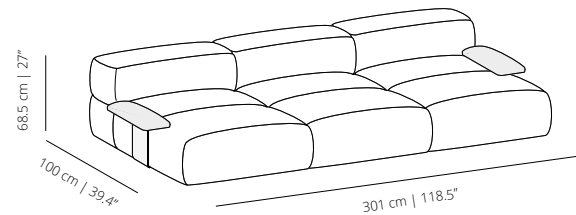

COMPOSITION 15
sofa

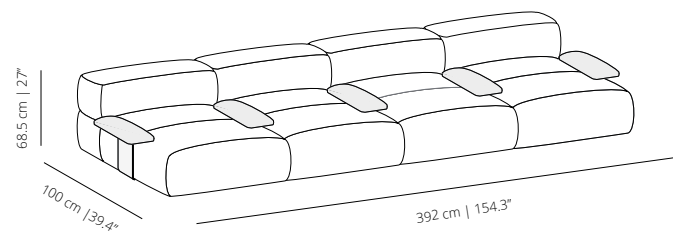

COMPOSITION 16
sofa

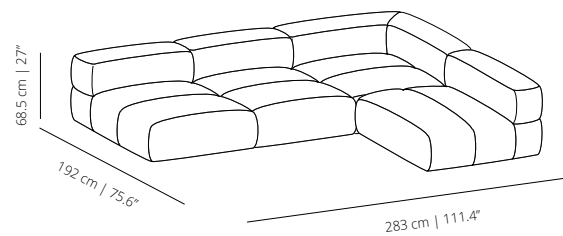

SAVINA SOFA - COMPOSITIONS

COMPOSITION 17
sofa

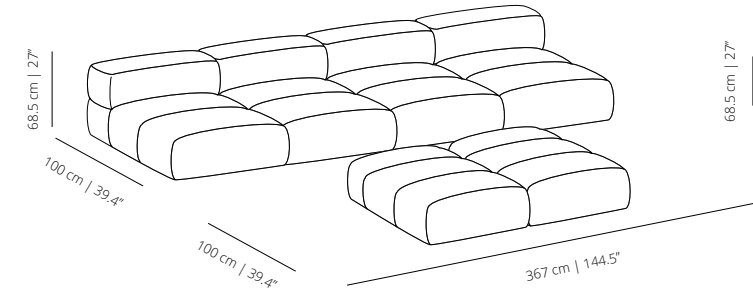

COMPOSITION 18
sofa

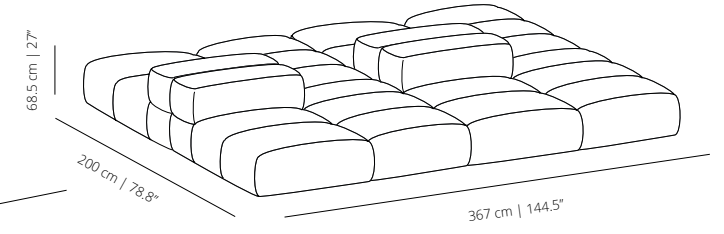

COMPOSITION 19
armchair

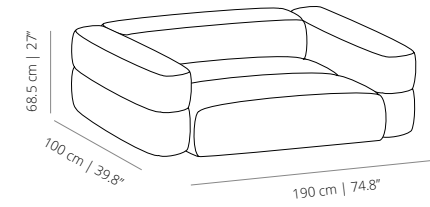

COMPOSITION 20
sofa

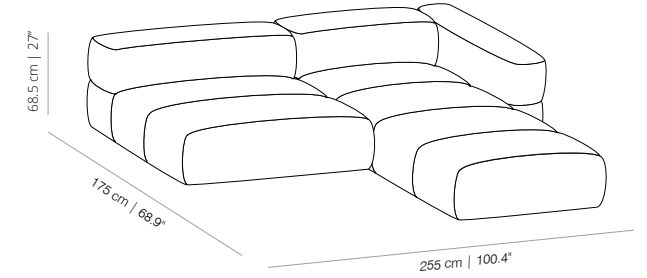

COMPOSITION 21
sofa

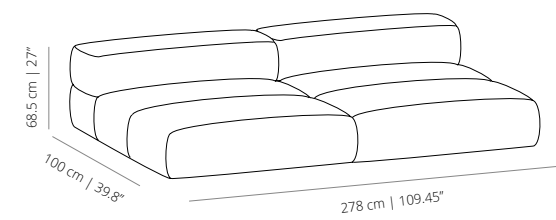

COMPOSITION 22
sofa

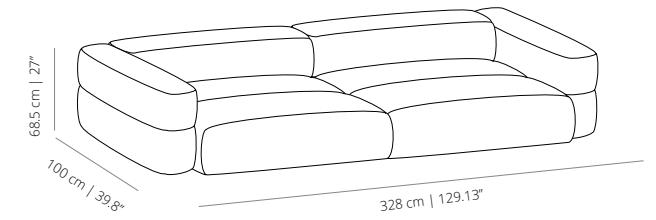

COMPOSITION 23
sofa

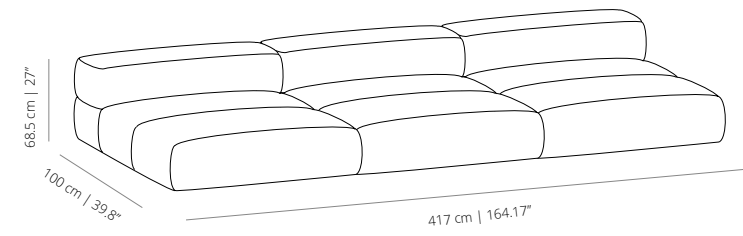

SAVINA SOFA - COMPOSITIONS

COMPOSITION 24 sofa

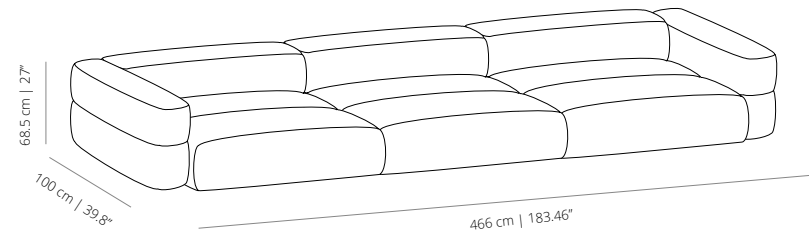

COMPOSITION 25 sofa

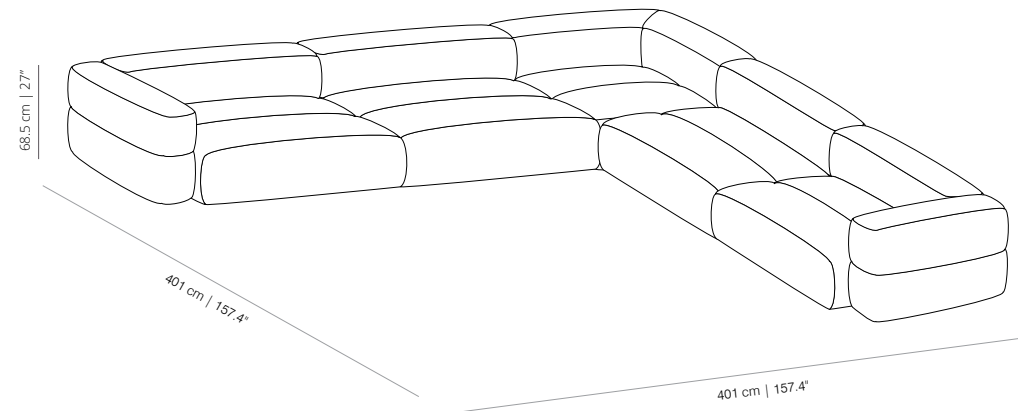

TECHNICAL INFO

Upholstery

Check [upholstery samples](#)



Seat/backrest. Solid wood frame with steel spring frame, non-deformable expanded polyurethane of different densities with viscoelastic layer, recycled PET fiber paneling and padded chamber filled with anti-mite feathers. Non-removable fabric or leather upholstery.



Legs/casters. Height adjustable legs or hidden casters.

ACCESSORIES & ELECTRIFICATIONS



Built-in SCHUKO powerbox/ USB hub. Built-in Schuko socket powerbox for device charging. Dimensions: Ø 5.7 cm



USB port. Built-in USB hub for charging electronic devices. Available in white or black for the sidetable in the preset positions. Dimensions: Ø 30 mm



Under table powerbox. Powerbox available with two sockets or combined with built-in multimedia devices. Dimensions: 16.8x5.4x5.4 cm



Built-in SCHUKO powerbox/ USB hub. Powerbox with one slot for socket or multimedia option. Dimensions: Ø6.6x15 cm

Let's talk

We want to help you find the best designs for your project. Get in touch and our team will get back to you as soon as possible.

+ CONTACT US